

N300710-AH

**Roller Shade Installation Instructions
(Motorization)**

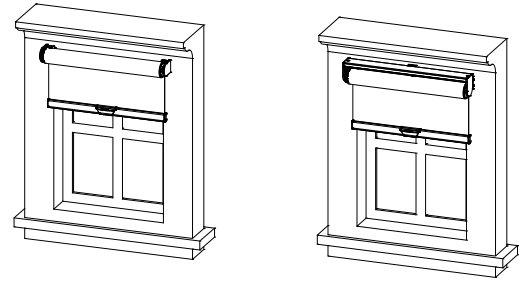

No Raceway With Raceway

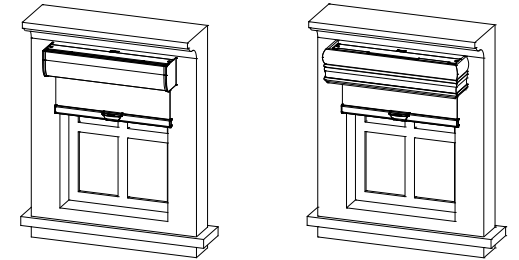

With Fascia With Valance

Recommended Tools

- Screw gun / Drill
- Tape Measure
- Screwdriver
- Level
- Pencil



Hardware Included

1. Screws needed for installing

Surface	Hardware	Drawing	Remark
Wood	1 1/4" Hexagon screw		To install shade brackets
	3/4" Flat head screw		To install remote holder
	3/4" Round head screw		To install traditional hold down bracket
	5/8" Flat head screw		To install magnet catch
Drywall/Plaster	Wall Anchors, Expansion Bolts		(Not Provided)
Metal	Sheet Metal Screws		(Not Provided)
	M3 x 3/8" Flat head screw		To install 8" fabric valance
	M4 x 3/8" Bolt M4 x 1/8" Nut		To install dual shade raceway

2. Hardware for Regular Roller Shade (No Raceway)

Hardware	Drawing	Usage
Shade Bracket		To install shade (on control side)

Shade Bracket		To install shade (on End Plug side)
Bracket Cover		Shade bracket cover (Pre-installed on the shade bracket)
Link Bracket		For Coupled Shades
Shade Bracket		For dual shades

3. Hardware for Roller Shade with Raceway System

Hardware	Drawing	Usage
Mounting Bracket		To install raceway (for outside mount & inside-back mount)
Shade Bracket		To install raceway (for inside mount)
Raceway Bracket Clip		To install shade bracket into raceway (for inside mount, pre-installed on the shade bracket)
Valance Bracket		To install fascia / valance (mounted on raceway)
Valance Clip		To install fascia/wood valance (placed on fascia/valance)
Elongated Valance Clip		To install / fabric valance (placed on valance)
Square Fascia End Cap		For square fascia
Curved Fascia End Cap		For curved fascia
Valance Return Connector		To connect wood valance returns
Valance Connector		To connect spliced wood valances
Valance Return Connector		To connect 3.5"/4.5"/6" fabric valance returns (pre-installed on the valance)
Valance Connector		To connect spliced fabric valances (pre-installed on the valance)
Raceway Connector		To connect raceway of coupled shades (for inside mount)
Raceway Connector		To connect raceway of coupled shades (for outside mount)
Raceway Bracket		For dual shades width $\geq 40"$
Shade Bracket		For dual shades

Valance Return Connector		For 8" fabric valance
Valance Connector		For 8" fabric valance (pre-installed on the valance)

4. Other Hardware

Hardware	Drawing	Usage
Traditional Hold Down Bracket		Optional
Magnet Catch		Optional (For magnetic hold down)
Spacer Block		Optional
Installation Tool		Scan the QR code on the tool for installation instructions

Regular Shade (No Raceway) Installation and Removal

Installation of Shade Brackets

When installing the shade bracket, the distance from the bracket's front mounting hole to the front edge of the window frame should be at least 3/4". Make sure both shade brackets line up with each other horizontally. Each shade bracket will require two 1 1/4" hexagon screws for the installation. For Inside Mount installation, first fit the bracket cover over the shade bracket, and then screw brackets into wall.

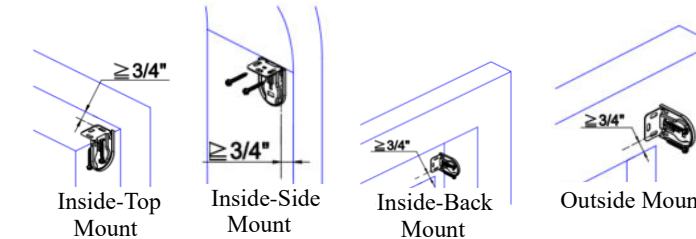

Installation of shade bracket for Dual Shades

When installing the shade bracket, the distance from the bracket's front/lower mounting hole to the edge of the window frame should be at least 3/4". Each shade bracket will require two 1 1/4" hexagon screws for the installation. Inside Mount

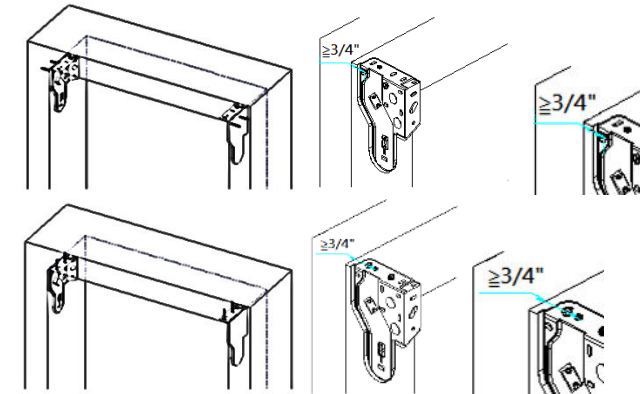

Outside Mount

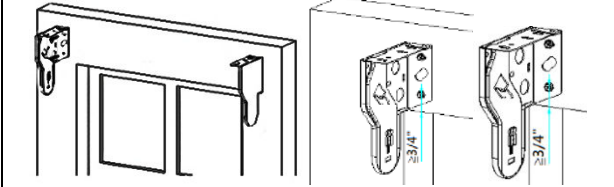

Installation of link bracket for Coupled Shades (2)&(3)&(4)

Each bracket will require two 1 1/4" hexagon screws for the installation. Make sure that the center of both the link bracket and the shade brackets line up and are level with each other.

Coupled Shades (2):

For standard coupled shades (2), the link bracket should face control side and install the shade of control side first. For independent coupled shades (2), the link bracket should face the right side and install right side shade first.

Inside Mount-Coupled Shades (2)

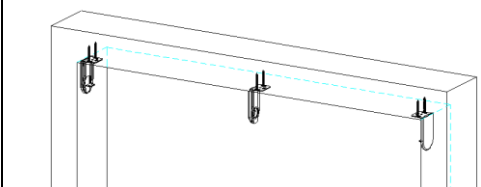

Outside Mount-Coupled Shades (2)

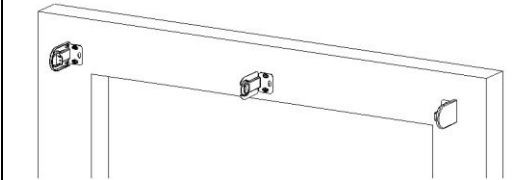

Coupled Shades (3):

Center left link bracket face left and center right link bracket face right. Install both control side shades first and then install center shade.

Inside Mount-Coupled Shades (3)

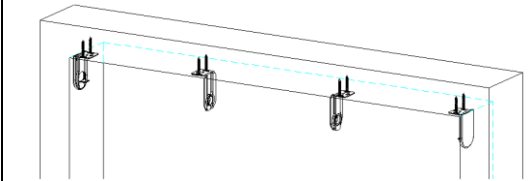

Outside Mount-Coupled Shades (3)

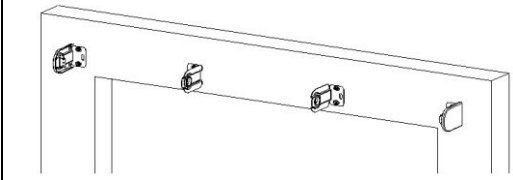

Coupled Shades (4):

Center left link bracket face left, center and center right link bracket face right. Install right side two shades first and then install left two shades.

Inside Mount-Coupled Shades (4)

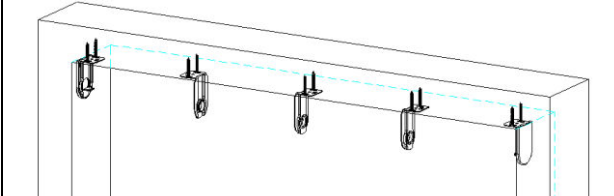

N300710-AH

Outside Mount-Coupled Shades (4)

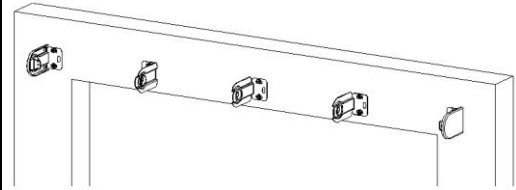

Link system (two shades to be operated together by one control)

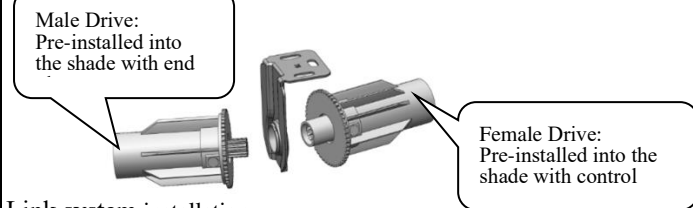

Link system installation:

- 1 Install the control side into the bracket for the control side.
- 2 Rotate the turntable about a third of a circle or directly press the female shaft and align it to the round hole of the link bracket, then turn the turntable back or release it so that it can be fitted into the link bracket.
- 3 Insert the male drive into the shaft of the female drive.
- 4 Install the end plug into the bracket for the end plug side.
- 5 Slide down the lock pin into the end plug.

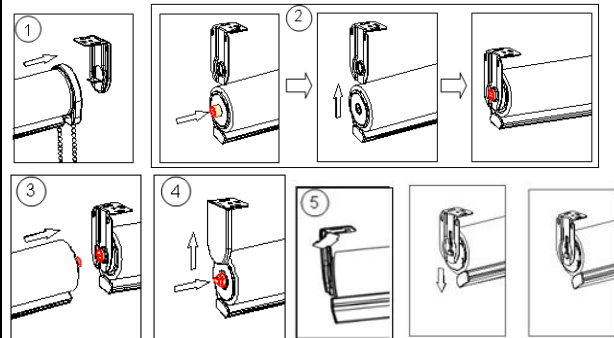

Link system (independently, control each shade independently).

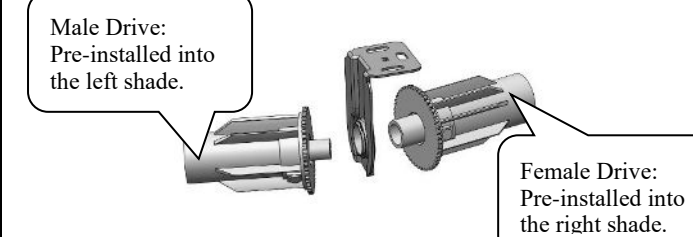

Link system (independently) installation:

- 1 Install the control side of the right shade into the right shade bracket.
- 2 Rotate the turntable about a third of a circle or directly press the female shaft and align it to the round hole of the link bracket, then turn the turntable back or release it so that it can be fitted into the link bracket.
- 3 Install the control side of the left shade into the left shade bracket.
- 4 Rotate the turntable about a third of a circle or directly press the male shaft and align it to the female shaft, then turn the turntable back or release it so that it can be fitted into the female shaft.

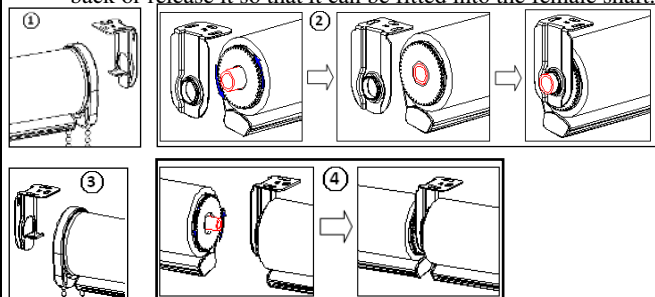

Shade Bracket Installation Tips

- 1 The top & bottom of left & right shade brackets should be at the same horizontal line.

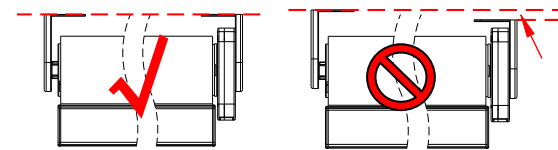

- 2 The front & back of left & right shade brackets should be at the same horizontal line.

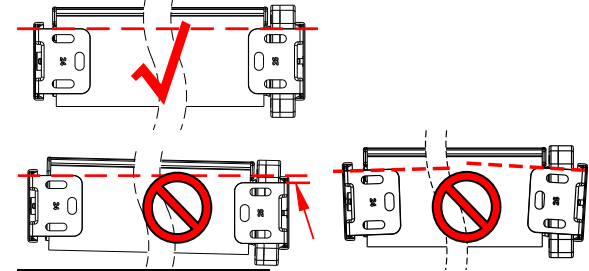

Installation of the Shade

▲ Use the installation tool for easier installation. Scan the QR code on the tool for installation instructions.

- 1 Insert the control side into the tongue of the bracket for the control side.
- 2 Press the end plug and insert the end plug into the hole of bracket of the other side.
- 3 Slide the lock pin in the shade bracket downward into the end plug to prevent the shade from falling.
- 4 Remove the paper band from the shade.

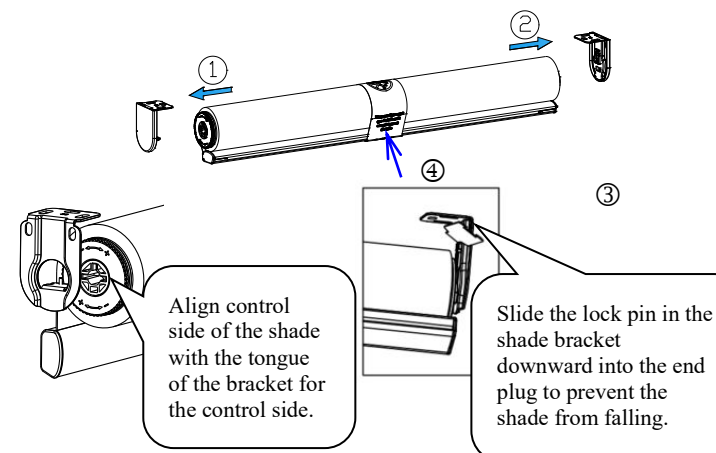

Shade Installation Tips: After shade is installed into shade brackets, use a Level to check if the fabrics roll is horizontal; if not, please adjust the position of shade brackets to keep the fabrics roll level. The distance between shade brackets equal to shade width.

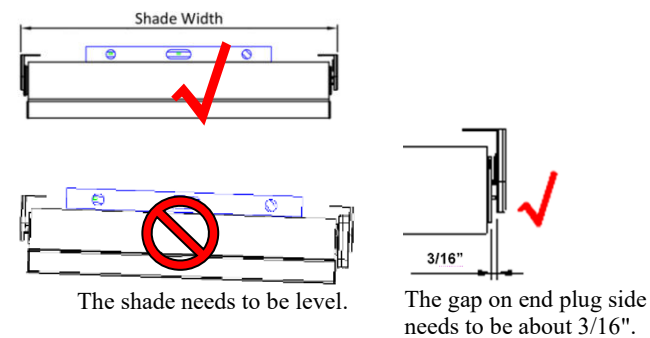

Removal of the Shade

▲ Use the installation tool for easier removal. Scan the QR code on the tool for removal instructions.

- 1 Use a tool to push the lock pin on end plug bracket upward.
- 2 Use tool to draw back the end plug from bracket.
- 3 Finally remove shade from mounting bracket. As shown in drawing.

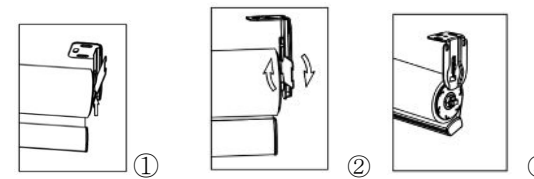

Raceway System Installation and Removal

Installation of Mounting / Shade Brackets

Inside Mount

Attach the shade brackets and raceway bracket clips into the two ends of the raceway. Make sure the raceway bracket clip's bolt locks into the raceway's dedicated hole.

Install the raceway into the window opening. We recommend securing the screws into the middle holes of the raceway first. This would allow you to adjust the raceway left or right if required. Once the correct position has been located, secure the screws for the holes. Take care that the distance between the 1st screw and the window edge is at least 3/4".

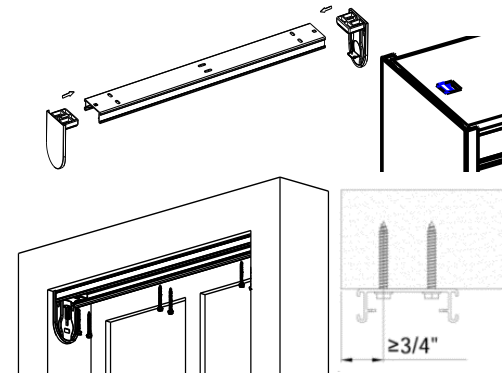

Outside Mount & Inside-Back Mount

There are two ways for outside mount & inside-back mount installation, choose whichever you need.

Install the bracket to wall first

- 1 Install the mounting brackets to wall and make sure all brackets line up with each other horizontally. Each bracket will require two 1 1/4" hexagon screws for the installation. The distance from wall to bracket's mounting hole should be at least 3/4" (for Outside Mount).

Outside Mount:

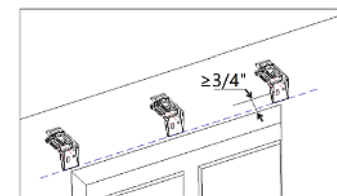

Scan to watch



Inside-Back Mount:

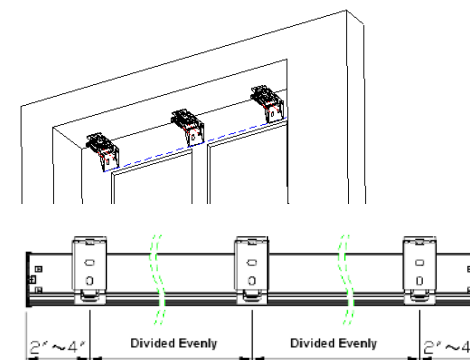

- 2 Locate the lock pin in the shade bracket on the end plug side. Slide the pin downward into the end plug to prevent the shade from falling.

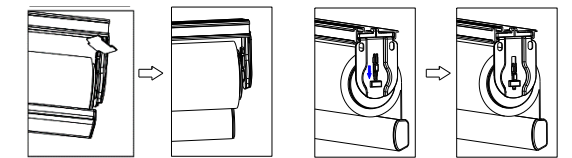

- 3 Insert the back edge of the raceway into the back plastic part of the bracket, and then turn the raceway upwards so that the front rib of the raceway snaps into the bracket.

- 4 Remove the paper band from the shade.

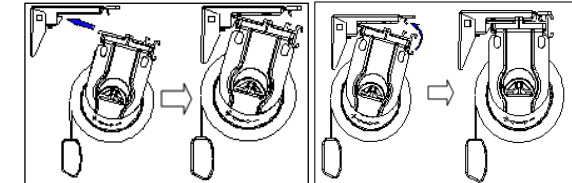

Install the bracket to raceway first

▲ Use the installation tool for easier removal. Scan the QR code on the tool for removal instructions.

- 1 Remove the shade from shade brackets:
 - a. Use a tool to push the lock pin on end plug bracket upward.
 - b. Use tool to draw back the end plug from bracket.
 - c. Remove shade from shade brackets. As shown in drawing.

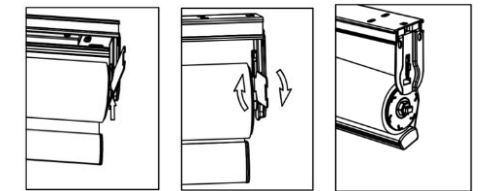

- 2 Insert the back edge of the raceway into the back plastic part of the bracket, and then turn the raceway upwards so that the front rib of the raceway snaps into the bracket.

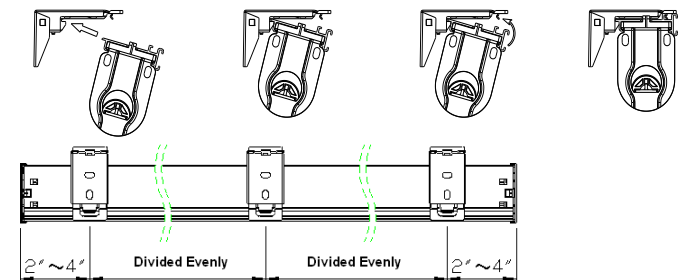

- 3 Install the raceway and mounting bracket to wall together. Install middle bracket first and adjust the raceway position. And then install brackets on both sides. Make sure the raceway is in horizontal position.

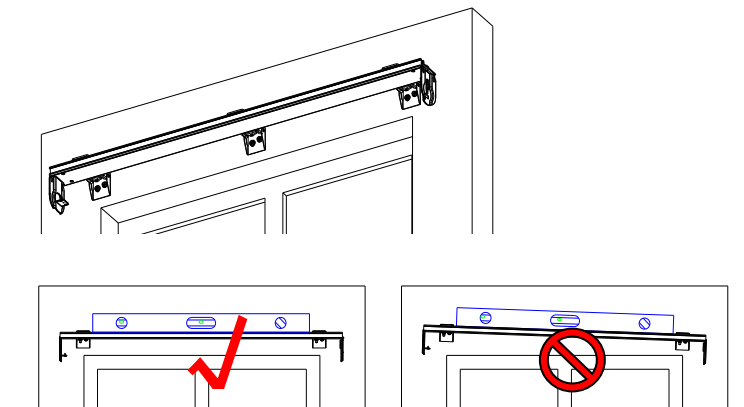

N300710-AH

Installation of the shade-IM&OM install bracket to raceway first

- 1 Insert the control side into the tongue of the bracket for the control side.
- 2 Press the end plug and insert the end plug into the hole of bracket of the other side.
- 3 Slide the lock pin in the shade bracket downward into the end plug to prevent the shade from falling.
- 4 Remove the paper band from the shade.

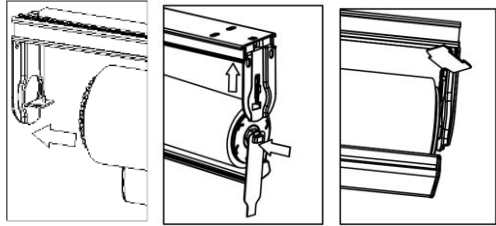

For dual shade,

- 1 Secure the bracket to the raceway using M4 x 3/8" bolt and M4 x 1/8" nut..
- 2 For dual shades 40" wide or more, a raceway bracket will be included. Install the raceway bracket on the back of the raceway. Position the bracket horizontally, slide it into place, then rotate it 90 degrees counterclockwise to lock it
- 3 Install the raceway.
- 4 Shade installation for dual shades follows the same process as a regular shade—always begin with the back shade before installing the front shade.

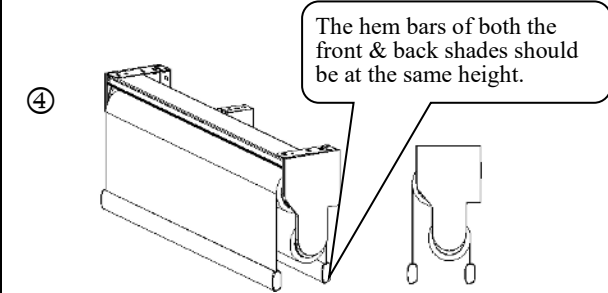
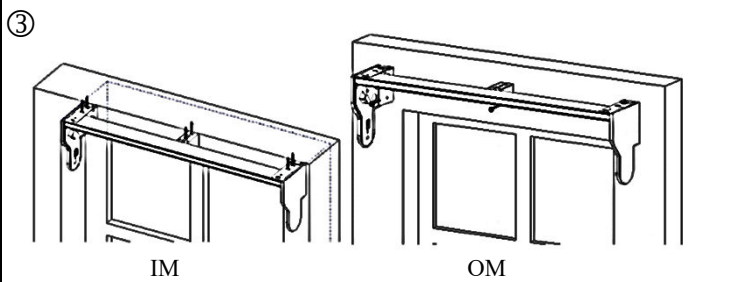
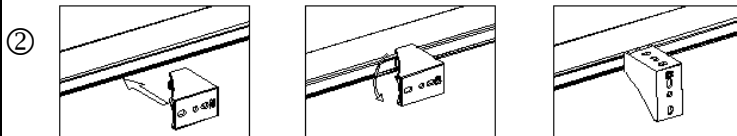
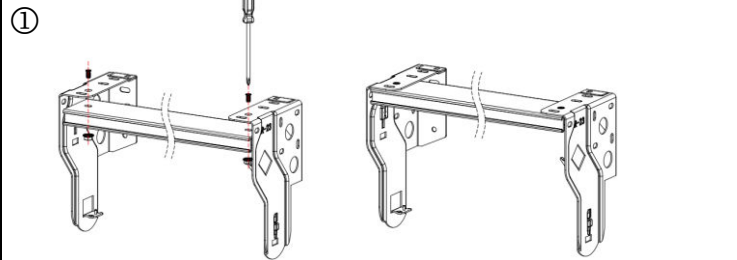

For coupled shade (2) & (3) & (4)

Installation of the shade brackets & raceway is the same as it is for a single shade. However, the raceway of coupled shades (2) & (3) & (4) is

supplied in separate pieces. Before installing the raceway to the wall / mounting brackets. Please follow below steps.

For IM raceway: Connect each raceway together by raceway connector and link bracket

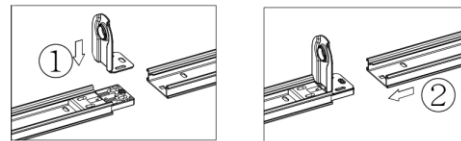

For OM raceway: Connect each raceway together by raceway connector and link bracket

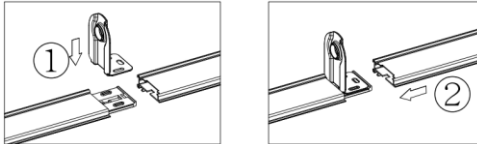

Removal of the Shade

▲ Use the installation tool for easier removal. Scan the QR code on the tool for removal instructions.
For inside mount, the shade removal is the same as a regular shade. Refer to the previous regular shade removal instructions for details.

For outside mount & inside-back mount use a tool to push back the front or back plastic part of the brackets, and then turn the back side of the raceway downward so that it detaches from the bracket. Finally remove the raceway by pulling downward from the brackets.

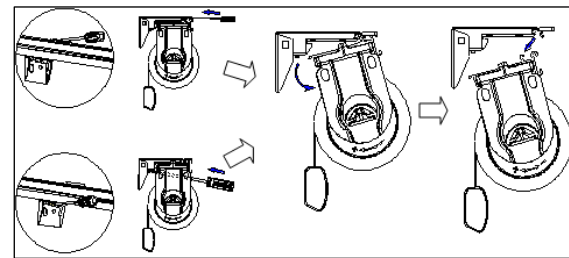

Hold Down Brackets Installation (optional)

A. Traditional Hold Down Bracket

Use 3/4" round head screw to secure each bracket.

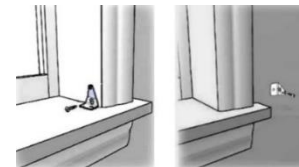

B. Magnetic Hold Down

Use 5/8" flat head screw to secure the magnet catch at the below location. Make sure the magnet catch aligns with the pre-installed magnet on shade bottom rail.

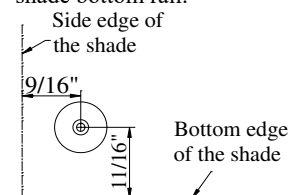

Shims Installation (optional)

If shims are included, secure the bracket and shims as below drawing. Make sure the bracket holes align to the shim holes.

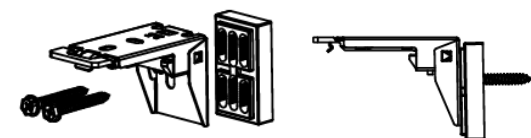

Installation of Cassette System

Installation of the Housing

Install the housing to the wall with 1 1/4" hexagon screws. Check to see if the window header is level. If not, use shims to level the housing.

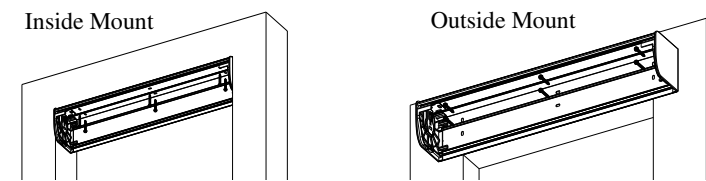

Installation of the Shade

The shade installation is the same as a regular shade. Refer to the previous regular shade installation instructions for details.

Installation of the Housing Cover

Note: Make sure the shade functions properly before installing the housing cover.
Hang the top edge of the housing cover on the housing, and then flip down the bottom of the housing cover into the end cap. Pay attention not to pinch the bead chain.

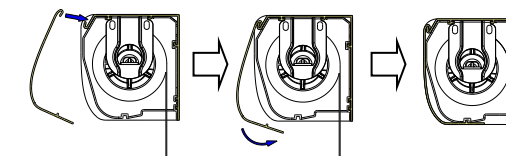

Removal of the Housing Cover

Flip down the bottom edge of the housing cover to detach from the housing end cap, and then remove the housing cover from above.

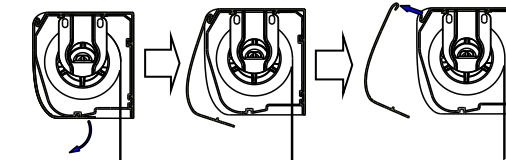

Note: The shade removal is the same as a regular shade. Refer to the previous regular shade installation instructions for details.

Fascia & Valance Installation

Valance Bracket Installation

After installing the shade and raceway, the brackets for the valance or fascia come next. Align the valance bracket with the raceway first and then push the bracket onto the raceway. The top groove of the valance bracket should hook onto the top of the raceway while the bracket's bottom groove clips into the bottom rib of the raceway, as shown below.

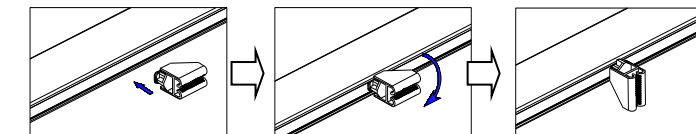

The drawing below shows the valance brackets installed in an ideal position. They are placed far enough apart so that the space is divided evenly.

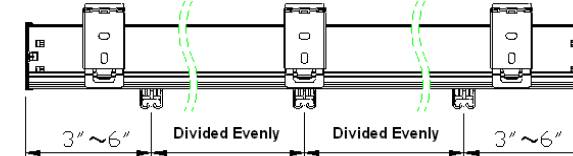

Valance Clip Installation

Insert the valance clip into the dedicated groove, paying special attention

to the direction of the valance clip. For a wood valance, the valance clip should face downwards. For fascia/fabric valance, it should face up. The valance clip location should align with the valance bracket as pictured below.

For Wood Valance/8" Fabric Valance::

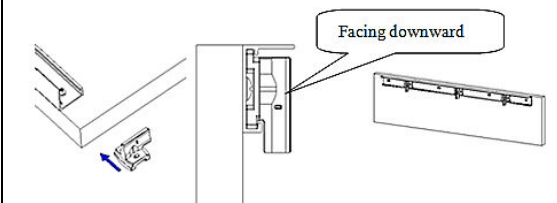

For 3.5"/4.5"/6" Fabric Valance:

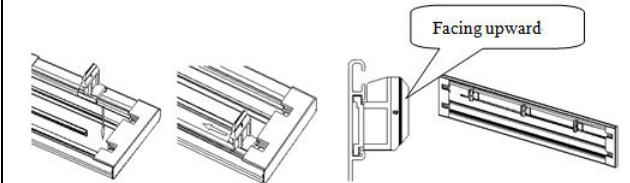

For Fascia:

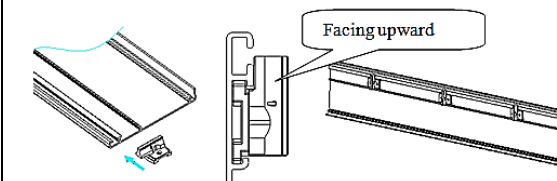

Attach Valance Return to Valance

Note: please skip this step if there is no return.

For wood valance:

- First insert valance return connector to return.
- Then attach return to valance.



For 3.5"/4.5"/6" fabric valance:

- First turn the return connectors in the back two end sides of valance to 90 degrees.
- Then attach return to valance.

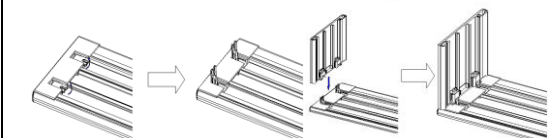

For 8" fabric valance:

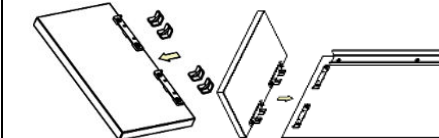

Attach Fascia End Cap to Fascia

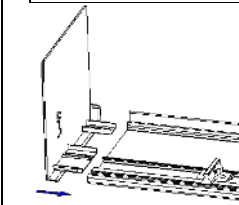

N300710-AH

Attach Valance/Fascia to Raceway

Slide the valance clips to a position on the valance/fascia so that they are each aligned with a valance bracket on the raceway, and then push the valance clips into the valance bracket. When installed correctly, you will hear a clicking sound.

For Wood Valance/8" Fabric Valance:

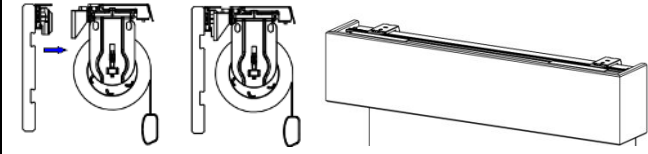

For Fascia / Fabric Valance:

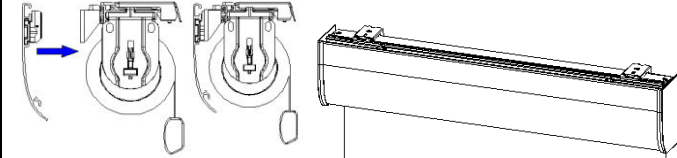

Valance/Fascia Keystone Installation

Keystones are needed on wood & fabric valances and fascias that require splicing.

Keystone for Fabric Valance

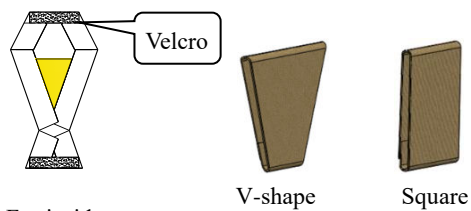

For inside mount

- ① Attach one piece of valance to raceway
- ② Insert the top of keystone into the gap between valance and window frame
- ③ Attach another piece of valance to the raceway
- ④ Make the bottom of keystone go around to the back and stick the Velcro on bottom & top of keystone together

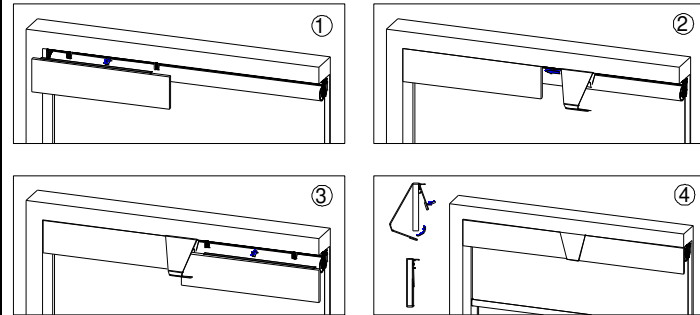

For outside mount

- ①&② Attach each piece of valances to the raceway
- ③ Place the keystone onto the joint where the two valance pieces meet. Then wrap the top and bottom flaps of the keystone around the top and bottom edges of the valance
- ④ Secure the keystone onto the valance with the included Velcro by affixing it toward the top and bottom of the keystone

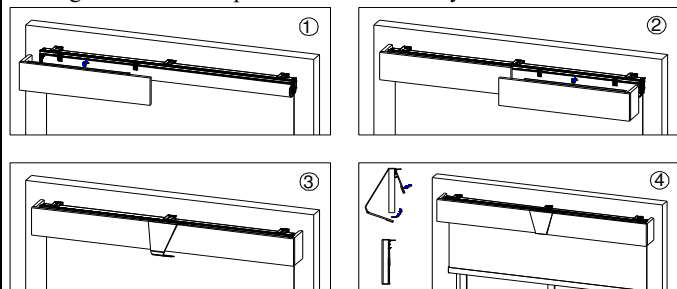

Keystone for Wood Crown Valance

- Insert the valance connectors into the keystone first, then align the left & right valances with the valance connectors and insert them to the keystone, finally use 2 screws to secure the valance on the keystone. As shown below:

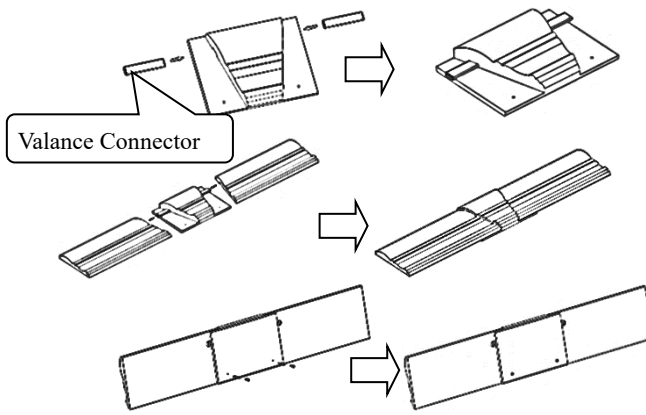

Keystone for Wood Modern Valance

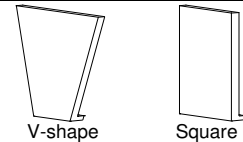

- Insert the valance connectors into the left & right valances first, then tear off the double-sided tape from the back of the keystone and stick it to the split position of the front side of the valances, finally use 2 screws to secure the valance on the keystone. As shown below:

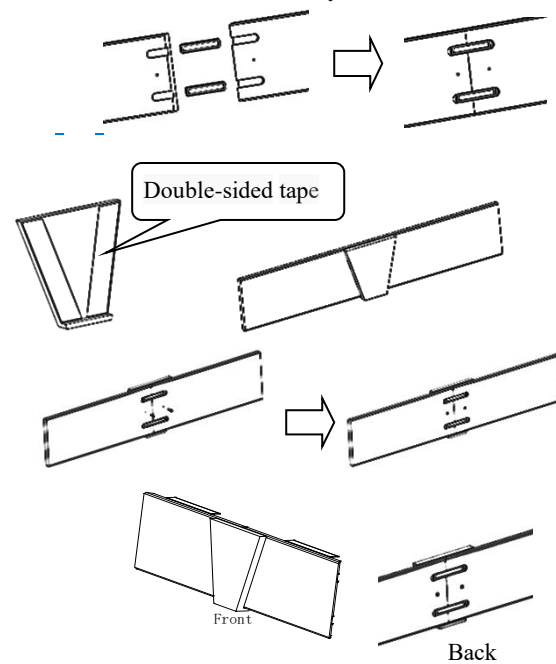

Keystone for Curved Fascia with Fabric

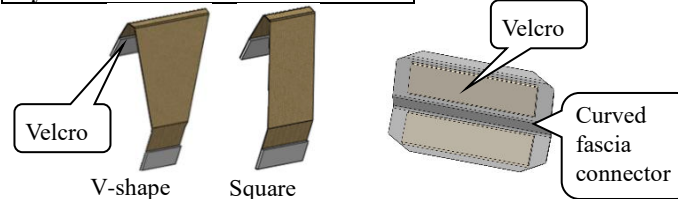

Installation:

- ① Align left and right fascias, and then slip the fascia connector from left fascia to right fascia
- ② Attach the Velcro on the top back of the keystone to the fascia connector
- ③ Wind the keystone to the front of the fascia, from the bottom edge of the fascia to the back, and attach the Velcro to the lower part of the fascia connector

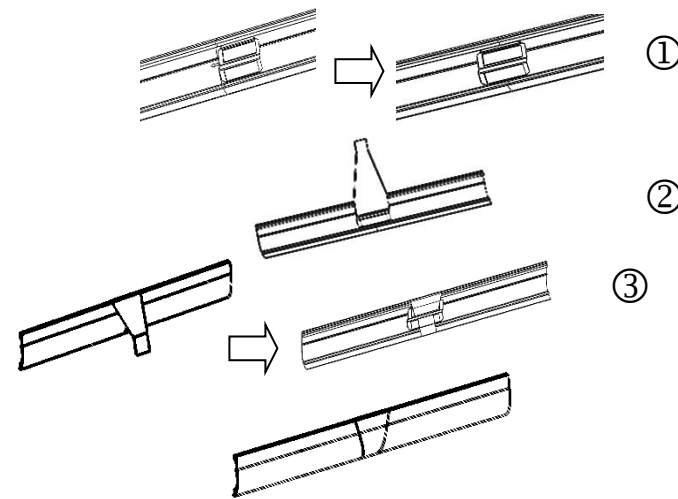

Keystone for Curved Fascia without Fabric

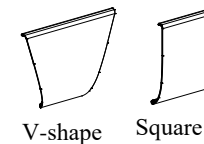

Installation: Insert the left & right fascias into the keystone, as shown below.

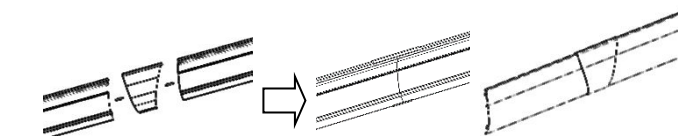

Keystone for Square Fascia

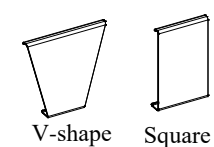

There are two connecting methods.

1. Insert the left & right fascias into the keystone, as shown below. (It is suggested to use for inside mount shade.)

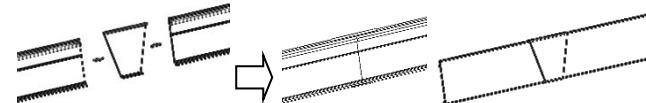

2. Place the keystone onto the joint where the two valance pieces meet, hook the top of the keystone around the top edges of the fascia and then push the bottom edge of the keystone into bottom edges of the fascia, as shown below. (It is suggested to use for semi-inside mount and outside mount shade.)



Valance Connector Installation

Wood Valance connector



Wood Modern Valance

Wood Crown Valance

Fabric Valance Connector

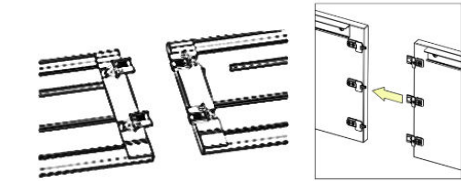

3.5"/4.5"/6"
Fabric Valance

8" Fabric
Valance

Fascia Connector Installation

Curved Fascia Connector

Align left and right fascias, and then slip the fascia connector from left fascia to right fascia.

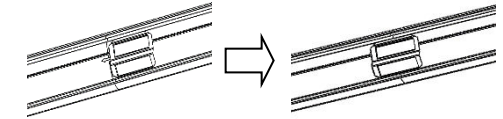

Square Fascia Connector

Align left and right fascias, and then stick the fascia connector to the split position of the back side of the left and right fascias.

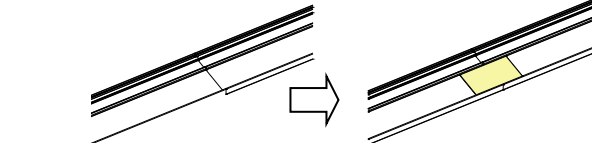

Valance/Fascia Removal

- First, remove valance/fascia together with valance clips and detach them from the valance brackets.

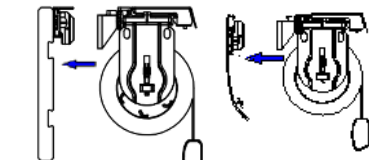

- Take down shade from mounting brackets before removing valance brackets from raceway.

- Turn the valance brackets 90 degrees, and then take off valance brackets from raceway, as shown below.

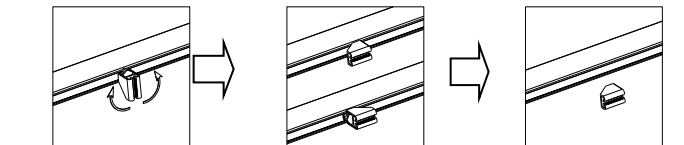

Note: The installation & removal for all fascias & valances are the same.

Motorized Installation

Automate/Low Voltage Motorization

To avoid motors waking and running during shipping process, motors are set as sleeping mode before shipped out. Please short press P1 once to activate motors before operating. After short pressing P1, the motors will wake, enabling it to run in a direction.

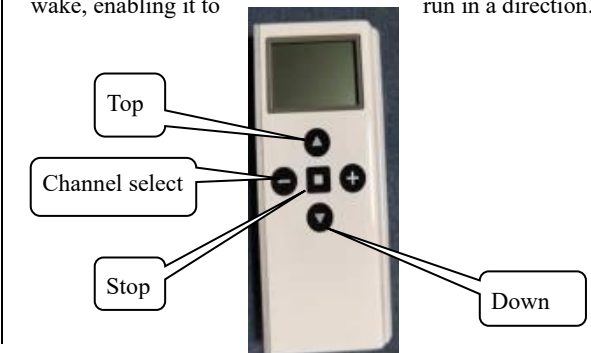

N300710-AH

15-Channel Remote:

There are total 15 channels (channel# 1~15) available. The shade will be default pre-program in channel 1 unless specified at the factory before shipping. The default setting from the factory for channel 0 is to operate all shades at once.

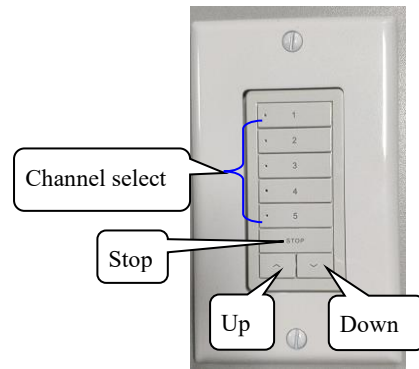

RF 5-Channel Wall Switch:

There are total 5 channels (channel# 1~5) available. The shade will be default pre-program in channel 1 unless specified at the factory before shipping.

AutoWand™ Motorization

Please connect the cable of the control wand to the motor, and then the shade will turn on automatically.

Use one 3/4" flat head screw to install the hook to the wall to hang the control wand. Hang the ring to the hook and control wand if needed.

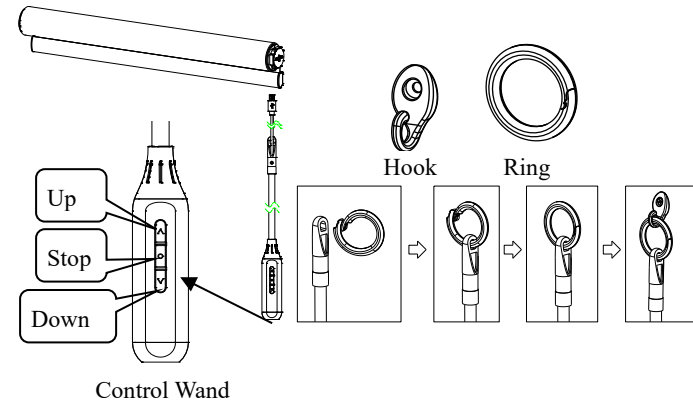

Norman Smart Motorization

Specification

NO.	Item	Specification
1	Power Source	MRS-32A: AC Power 100-240V, 50 / 60Hz MRS-32A DC Low Voltage 12V or 24V, 2A Max MRS-32B/32C: Battery Power Li-ion batteries
2	Battery Operating Voltage Range	4.2V~3.4V (Single cell)
3	Radio Type	2.4G RF
4	Frequency Band(s)	2415~2459MHz
5	Motor Type	Brush DC motor
6	Charge Type	Charging Wand for MRS-32B Power Adapter for MRS-32C
7	Charging Time	< 3 hours

8	Charging Temperature	5°C/41°F ~ 35°C/95°F
9	Operating Temperature	0°C/32°F ~ 40°C/104°F
10	Relative Humidity	0% ~ 90% (Non-condensing)
11	Ave. Sound Level @1m	≤ 50dBA

Safety Precautions

Thank you for your purchase. Please review the instructions carefully before using the product, and save these instructions for future consultation.

- **WARNING!** Important safety instruction: It is critical for your safety and the safety of those around you to follow these instructions. Please save these instructions for future use.
- **WARNING!** The motor/shade must be disconnected from its power source during cleaning, maintenance and when replacing parts.
- The products may contain Lithium-ion batteries; the battery contains flammable materials such as organic solvents. Please read the Important Safety Precautions before using the product.
- Please recharge the batteries every 3-6 months to ensure optimal performance of batteries.
- Product operation is intended for temperatures between 0°C/32°F ~40°C/104°F.
- Please note that the limited warranty will be voided if the product is modified, dismantled or used in any manner other than its intended purpose.
- The accessories, including Charging Wand, Adapter, and Remote are designed to be used with our Motorized Shades. Do NOT use them for any other purpose.
- Please make sure the shade route is clear when operating to avoid danger or damage.
- In order to improve the user experience and functionality, the firmware and software of this product will automatically update from time to time.
- **WARNING!** For the purposes of recharging the battery, only use the detachable supply unit provided with this appliance. Detachable supply unit (UHVUU3036-240015SA/MX36W1-2401500U)
- Do NOT disassemble the products or any of their components. They do not contain serviceable parts. Servicing of these products should be referred to qualified personnel.
- This appliance contains batteries that are only replaceable by skilled personnel, trained authorized retailer or electrician.
- Do NOT operate the product with wet hands to avoid risk of electrical shock. The product needs to be powered off and disconnected from its power source during cleaning, maintenance and/or replacing parts.
- The appliance is not intended for use by persons (including children) with reduced physical, sensory or mental capabilities, or lack of experience and knowledge, unless they have been given supervision or instruction concerning use of the appliance by a person responsible for their safety. Children should be supervised to ensure that they do not play with the appliance.
- The appliance is only to be used with the power supply unit provided with the appliance.
- If the supply cord is damaged, it must be replaced by the manufacturer, its service agent or similarly qualified persons in order to avoid a hazard.
- **WARNING:** Important safety instructions. It is important for the safety of persons to follow these instructions. Save these instructions.
- **WARNING:** Important safety instructions. Follow all instructions, since incorrect installation can lead to severe injury

- before installing the drive, remove any unnecessary cords or components and disable any equipment not needed for powered operation;
- the characteristics of the driven part must be compatible with the rated load and rated operating time;
- the mass and the dimension of the driven part shall be compatible with the rated torque and rated operating time;
- fixed controls have to be clearly visible after installation;

- This appliance contains batteries that are only replaceable by skilled persons.
- Do NOT operate when maintenance, such as window cleaning, is being carried out in the vicinity.
- **IMPORTANT:** Please reserve space for connecting the Power Charger while installing the shade, please refer to "Installation" Section for more information.
- Do not allow children to play with fixed controls. Keep remote controls away from children.
- Frequently examine the installation for imbalance and signs of wear or damage to cables springs and fixings. Do not use if repair or adjustment is necessary.
- LpA ≤ 70 dB (A).

Installation

Please take a moment to review the following installation guide. The installation of mounting brackets and shades is same as non-motorized shades.

Check components for AC adapter Plug-In (MRS-32A)

36W Adapter		
36W Adapter	Connector Cord	Extension Cord (optional)

65W Adapter			
65W Adapter	AC Power Cord	Extension Cord (optional)	1" Screw for 65W Adapter

Check components for DC low voltage hard wire (MRS-32A)

Connector Cord	DC Connection Harness

Check components for rechargeable battery with charging wands (MRS-32B)

Wireless Charging Wand	
36W Adapter	Charging Wand
Wired Charging Wand	
36W Adapter	Extension Cord
Extension Pole for Charging Wand (optional)	Charging Wand

Check components for rechargeable battery with AC adapter charger (MRS-32C)

36W Adapter	32C's Adapter Connector Cord	Extension Cord (optional)

Remote

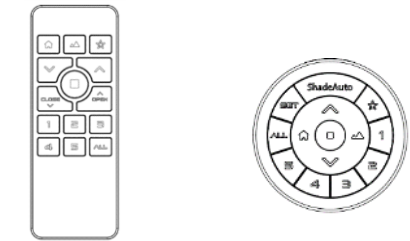

Remote Holder Installation (For Basic Remote):

A. Plaster Wall (Use Installation Screws)

1. Place the remote holder at desired location, and use the pencil to mark the locations of the screws.
2. Place the remote holder against the wall and use two 3/4" flat head screws to secure the remote holder.

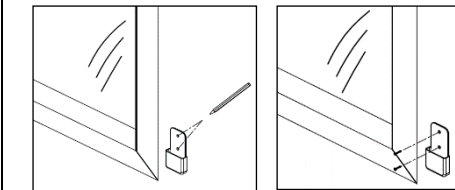

B. Smooth Wall (Marble Wall, Quartz Wall, Glass - Use Adhesive Sticker)

For hard surfaces, such as marble, quartz, etc. it is recommended to use the double-sided foam tape provided. Tear off the double-sided tape on the backside of the remote holder, and stick the remote holder to the desired location.

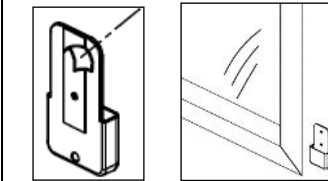

AC Adapter Plug-In (MRS-32A) with 36W adapter:

Please connect the connector cord to the adapter, and then plug the connector cord into the cable of the motor, last plug the adapter to the outlet. If there is extension cord ordered, then connect the extension cord between connector cord and adapter.

The shade will turn on automatically after plugging into the outlet. The indicator light will blink green.

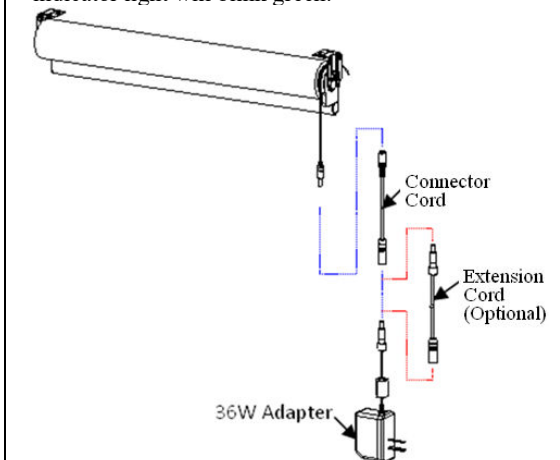

N300710-AH

AC Adapter Plug-In (MRS-32A) with 65W adapter:

Please connect the adapter to the cable of the motor, and then plug the AC power cord into the adapter, last plug the AC power cord into to the outlet. If there is extension cord ordered, then connect the extension cord between adapter and cable of the motor.

The 65w adapter will be supplied with 2 pcs of 1" screws, which can be used to fix the adapter if needed.

The shade will turn on automatically after plugging into the outlet. The indicator light will blink green.

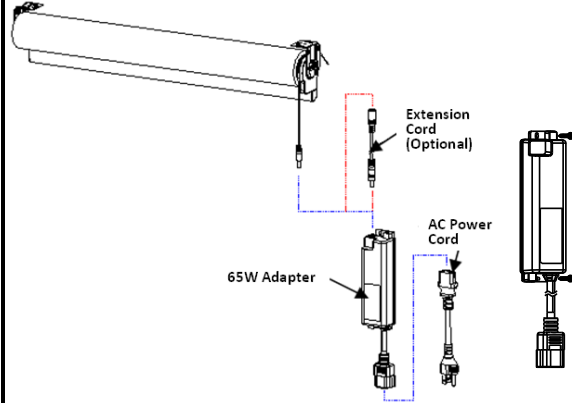

DC Low Voltage Hard Wire (MRS-32A):

Please connect the connector cord into the cable of the motor, and then connect the connector cord with DC connection harness, last plug the DC connection harness to the DC power panel.

The shade will turn on automatically after plugging into the outlet. The indicator light will blink green.

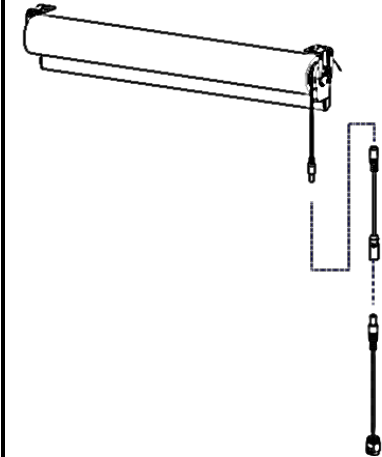

Rechargeable Battery with Charging Wands (MRS-32B):

Please connect the wire line in the charging port with motor cable, and then put the lines into the charging port and plug the charging port to the holder bracket.

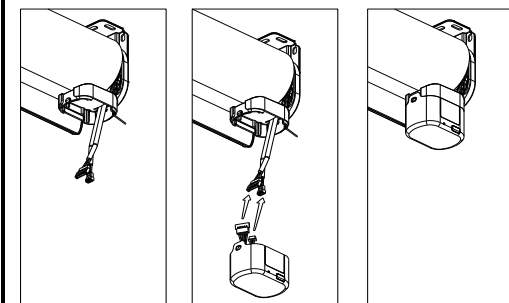

When installing the shade, a minimum shade height is required for shades installed within bottom window / windowsills / obstacles.

System		Min shade height	
		Wireless Charging Wand	Wired Charging Wand
Roller without Top Treatment / with Raceway	Small Shade Bracket	39 1/2"	40 7/8"
	Medium Shade Bracket	39 13/16"	41 3/16"
	Large Shade Bracket	40 3/8"	41 3/4"
Roller with Fascias/ Valances	3.5" Fascia/ Valances	40 1/4"	41 5/8"
	4.5" Fascia/ Valances	40 13/16"	42 3/16"

Note: If Extension Pole is ordered, it needs to add 33 11/16" to above min height size.

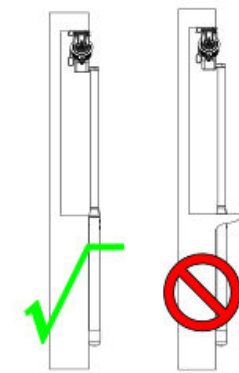

Rechargeable Battery with AC adapter charger (MRS-32C):

For single and coupled shades, the shade button is facing downward. For dual shades, the shade button is facing the front.

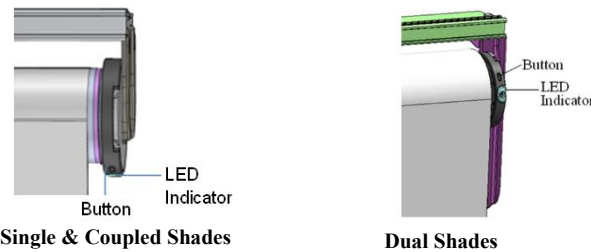

CHARGING THE SHADE (MRS-32B & MRS-32C)

Warning!

- Please charge the shade before use!
- Please DO NOT use the shade when charging.
- Please recharge your shade every 3~6 months to ensure optimal performance of batteries.
- For shade with MRS-32B, please only use the charging wand included with this product. If using the extension cord, please DO NOT bend or twist the cord to avoid product damage or safety hazard.
- For shade with MRS-32C, please only use the 36W AC Adapter included with this product. If using the extension cord, please DO NOT bend or twist the cord to avoid product damage or safety hazard.
- After charging, please store the 36W AC Adapter, extension cord for later use.

SHADE OPERATION

For Shade with MRS-32A AC Adapter, the shade will power on as soon as the power is connected.

For Shade with MRS-32B and MRS-32C Battery Power, press and hold the shade button for 3 seconds and the green light will flash to indicate that it is powered on and ready for operation.

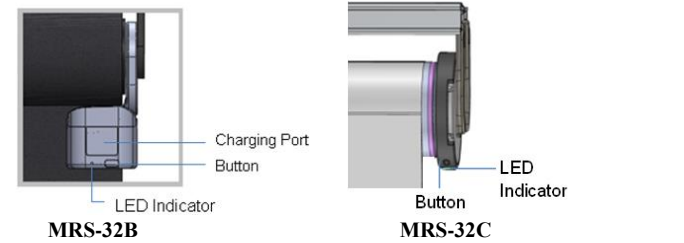

Operating the Shade by Remote Control

Select the group of the shade (it can select one or multiple groups at same time), press OPEN to fully raise the shade (fully open position).



Select the group of the shade (it can select one or multiple groups at same time), press CLOSE to fully lower the shade (fully close position).



Select the group of the shade (it can select one or multiple groups at same time), press ▲ or ▼ to adjust shade location.



- ▲ : Move to Best View
- ★ : Move to My Favorite
- : Stop the shade
- ▲ : Move to Best Privacy

Note: "All" button default controls all shades at same time.

Operating the Shade with Shade Button

When the remote is out of reach, the shade can be operated by shade button. Press the button to move the shade in first direction when the shade is still. Press the button to stop the shade while the shade is in motion.

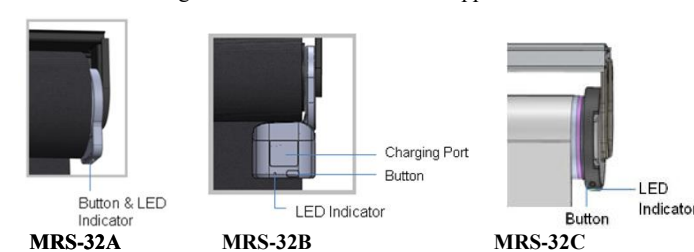

TROUBLESHOOTING

Problems	Possible Cause	Description
No reaction upon operation	No Signal	Operate the shade with the remote and check the LED indicator on the shade. Green light blinks: The shade receives signal normally. Red light blinks: Low battery / Over temperature limit Red/Green light blinks: Other problems No light: Not receiving signal / Not paired with a Remote / The shade is powered OFF.
	Low battery of Remote	Please check if the remote group lights work normally, or replace with new batteries.
	Low battery of Shade	Please use charging wand to charge the shade with MRS-32B. Please use 36W Adapter to charge the shade with MRS-32C.

The shade is not paired with the Remote	Press and hold the paired Group button and check if the shade responds. Shade response as shift x 1 means it has been paired. Shade has no response means it needs to be paired first. Please refer to "Remote Control Manual" for pairing steps.	
Over Temperature Protection	The shade might be overheated when the LED indicator on shade blinks red during operation. Please wait at least 30 minutes and operate the shade again. Please refer to the Specifications for applicable operating temperature.	
The limits are not fully setup.	Press ▲ / ▼ on Remote to operate the shade and check if the shade LED blinks green and the shade works normally. If not, the shade limits might not be fully set up for full functionality. Please refer to "Remote Control Manual" to set up shade limits again. IMPORTANT! Upper and Lower limits must be setup for full function of the shades.	
Other Problems	Re-power ON : Hold the shade button for 3 seconds to power the shade ON/OFF. If the problem still exists, please try "Hardware reboot". Hardware reboot : Hold the shade button for 10 seconds until the red light illuminates and the shade will reboot. If the problem still exists, please contact your customer service for further assistance.	
Limits shift	Abnormal power failure	Abnormal power failure may cause an unintended change to the shade limits. Please refer to "Remote Control Manual" to set up limits again.
	Others	Please contact customer service for further assistance.
The shade direction is reversed from remote.	Miscommunication between remote and motor Step 1: 8 rapid presses of the shade button. (Shade light illuminate GREEN) Step 2: Press & hold the shade button for 5 seconds. The signal light will blink green and the shade will jog once. The motor direction is changed. **Note: when motor direction is changed, all the limits and scene have to be re-set again.**	

SAFETY STATEMENT

Federal Communication Commission Interference Statement

This device complies with Part 15 of the FCC Rules. Operation is subject to the following two conditions: (1) This device may not cause harmful interference, and (2) this device must accept any interference received, including interference that may cause undesired operation.

This equipment has been tested and found to comply with the limits for a Class B digital device, pursuant to Part 15 of the FCC Rules. These limits are designed to provide reasonable protection against harmful interference in a residential installation. This equipment generates, uses and can radiate radio frequency energy and, if not installed and used in accordance with the instructions, may cause harmful interference to radio communications. However, there is no guarantee that interference will not occur in a particular installation. If this equipment does cause harmful interference to radio or television reception, which can be determined by turning the equipment off and on, the user is encouraged to try to correct the interference by one of the following measures:

- Reorient or relocate the receiving antenna
- Increase the separation between the equipment and receiver.
- Connect the equipment into an outlet on a circuit different from that to which the receiver is connected.
- Consult the dealer or an experienced radio/TV technician for help.

FCC Caution: Any changes or modifications not expressly approved by the party responsible for compliance could void the user's authority to operate this equipment.

This transmitter must not be co-located or operating in conjunction with any other antenna or transmitter.

N300710-AH

Industry Canada Equipment Standard for Digital Equipment (ICES) – Canada

This Class B digital apparatus complies with Canadian ICES-003. Cet appareil numérique de la classe B est conforme à la norme NMB-003 du Canada. CAN ICES-3 (B)/NMB-3(B)

Innovation, Science and Economic Development Canada (ISED) Compliance Statement

This device complies with ISED's licence-exempt RSS standard(s). Operation is subject to the following two conditions: (1) this device may not cause interference, and (2) this device must accept any interference, including interference that may cause undesired operation of the device.

Le présent appareil est conforme aux CNR d'ISED applicables aux appareils radio exempts de licence. L'exploitation est autorisée aux deux conditions suivantes : (1) le dispositif ne doit pas produire de brouillage préjudiciable, et (2) ce dispositif doit accepter tout brouillage reçu, y compris un brouillage susceptible de provoquer un fonctionnement indésirable.

Radiation Exposure Statement:

This equipment complies with FCC/ISED radiation exposure limits set forth for an uncontrolled environment. This equipment should be installed and operated with greater than 20cm between the unit & your body.

Déclaration d'exposition aux radiations:

Cet équipement est conforme aux limites d'exposition aux rayonnements FCC/ISED établies pour un environnement non contrôlé. Cet équipement doit être installé et utilisé à plus de 20cm entre le radiateur et votre corps.

SAFETY INSTRUCTIONS FOR LITHIUM BATTERIES

The product may contain lithium-ion batteries; the battery contains flammable materials, such as organic solvents. Mishandling of the battery may cause fire, smoke, or explosion.

DANGER

Do not immerse the battery in any liquid, such as water, beverages, or other fluids. Exposure to liquid may damage the battery or the battery pack. Damaging the battery may generate heat, smoke, catch fire, or explode.

Do not use or place the battery in or near an open flame, heater or high temperature areas (above 80°C or 176°F), such as those near a microwave or other cooking appliance.

Subjecting the battery to high temperature or near electromagnetic radiation may damage the polyolefin separator and can cause short circuit. This may cause the battery to generate heat, smoke, catch fire, or explode.

About Charging: Do not use unauthorized chargers.

Only charge the battery within recommended conditions (e.g., temperature range, voltage, and current). Use of an unauthorized charger could cause the battery to generate heat, smoke, catch fire, or explode.

Do not attach or insert battery with polarity reversed.

If the battery does not easily fit into the charger or device, check the battery orientation. Do not force the battery into the compartment. If the battery is inserted incorrectly, the battery may generate heat, smoke, catch fire, or explode.

Do not connect the battery to an AC outlet or DC automotive plug.

The battery requires a specific charger. If the battery is connected directly to a power outlet, the battery may generate heat, smoke, catch fire, or explode.

Do not use the battery in equipment for which it was not intended.

If the battery is used in unapproved applications or systems, the battery may be damaged and generate heat, smoke, catch fire, or explode.

Keep the battery away from heat and fire.

Excessive heat will damage the battery and may cause it to generate smoke, catch fire, or explode.

Do Not connect the positive (+) and negative (-) terminals with a conductive material. Do not carry or store the battery with any metal objects. If the battery is shorted, it may overheat and the battery may generate heat, smoke, catch fire, or explode.

Avoid excessive impact to the battery.

Impact beyond specification may damage the battery. This may cause the battery to leak, generate heat, smoke, catch fire, or explode.

Do not penetrate the battery with any sharp object.

If subjected to a hard strike or penetrated by an object, the battery may be damaged, thereby causing the battery to short-circuit. This may cause the battery to generate heat, smoke, catch fire, or explode.

Do not directly solder to the battery.

Soldering directly to the battery could melt the separator, damage the fume release vent or other safety mechanisms. This may cause the battery to generate heat, smoke, catch fire, or explode.

Do not disassemble the battery.

Disassembly or modification of the battery may damage the protection circuit.

This may cause the battery to generate heat, smoke, catch fire, or explode.

Do not charge the battery near high temperature.

If the battery is charged while exposed to high temperature, the battery's protection circuit may activate and prevent charging, or fail and cause the battery to generate heat, smoke, catch fire, or explode.

WARNING

Ingestion

Keep away from small children.

Keep the battery away from small children. If the battery or any of its component parts is swallowed, seek medical attention immediately.

Mixed Use

Do not mix with other batteries.

The battery should not be used with other batteries having a different capacity, chemistry, or manufacturer. Doing so could cause the battery to generate heat, smoke, catch fire, or explode.

Rust, Discoloration and Deformities

Do not use abnormal batteries.

Immediately stop using the battery if there are noticeable abnormalities, such as smell, heat, discoloration, or deformity. The battery may be defective and could generate heat, smoke, catch fire, or explode with continued use.

Charging Time

Stop charging if the charging process cannot be finished.

If the battery cannot finish the charging process within the specified time, halt the charging process. The battery may generate heat, smoke, catch fire, or explode.

Leakage -1

Do not use a leaking battery near open flame.

If the battery or liquid leaking from the battery has an irritating odor, the battery should be kept away from any open flame. If exposed to an open flame, the battery could ignite and explode.

Leakage -2

Do not touch a leaking battery.

If liquid leaking from the battery gets into your eyes or makes contact with your skin, immediately flush your eyes or skin with clean water and seek medical attention. If left untreated, it will cause significant eye or skin damage.

Transport

Pack the battery securely for transport.

To prevent short-circuit or damage during transport, securely pack the battery in a case or carton.

CAUTION

Exposure to Direct Sunlight

Do not use or leave the battery in a location exposed to excessive heat, such as in direct sunlight or in a car. Doing so could cause the battery to generate heat, smoke, catch fire, or explode. It may also cause the battery's performance and life to deteriorate.

Use with other Equipment or Power

The battery pack has a protection circuit. Do not use the battery with other equipment or power as it may damage the protection circuit. If the protection circuit fails, the battery may generate heat, catch fire, smoke, or explode.

Charging Temperature Range

Only charge the battery between 5°C and 35°C. Charging outside of this temperature range may cause the battery to leak, generate heat, or result in serious damage. It may also cause the battery's performance and life to deteriorate.

Charging Method

Read the user's manual for proper product charging method.

First Time Usage

Please contact the supplier if the battery gives off an unusual odor, generates heat, or shows signs of rust prior to its initial use.

Flammable Materials

Do not charge or discharge near flammable materials. Doing so could result in fire.

Handling of Exposed Contacts or Conductors

If the battery pack has a system interface consisting of stripped lead wires or exposed contact plates, handle with due care. Temporarily insulate exposed contacts and conductors with an insulator such as polypropylene tape or polyvinylchloride tape. Failure to do so could result in an electrical shock; a short circuit causing the battery to generate heat, smoke, catch fire, or explode; or the combustion of other materials.

Recycling

When disposing of the battery, recycle it according to local rules and regulations.

Light Guard Installation Instruction

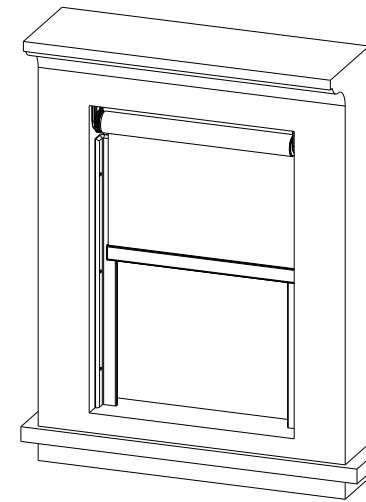

Hardware included

1. Screws needed for installing

Surface	Hardware	Drawing	Remark
Wood	1 1/2" flat head screw		To install premium wood light guard
	3/4" flat head screw		To install basic light guard
	3/4" round head screw		To install top light guard holder

2. Other Hardware

Hardware	Drawing	Usage
Top light guard holder		To install top light guard
Raceway light guard holder		To install top light guard into raceway
Transparent Adhesive Tape		To join the spliced basic light guard
Light guard end cap		Pre-installed on the top of the basic light guard

Installation of Top Light Guard

For regular roller shade

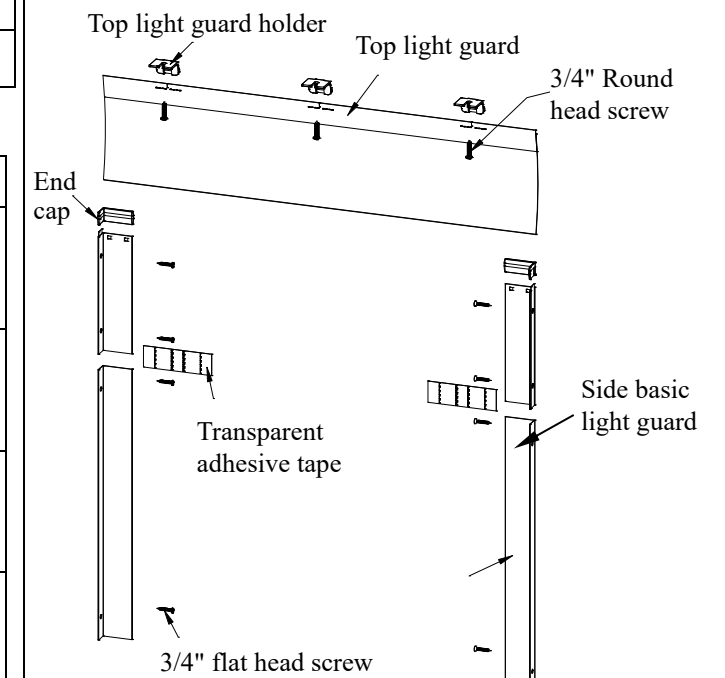
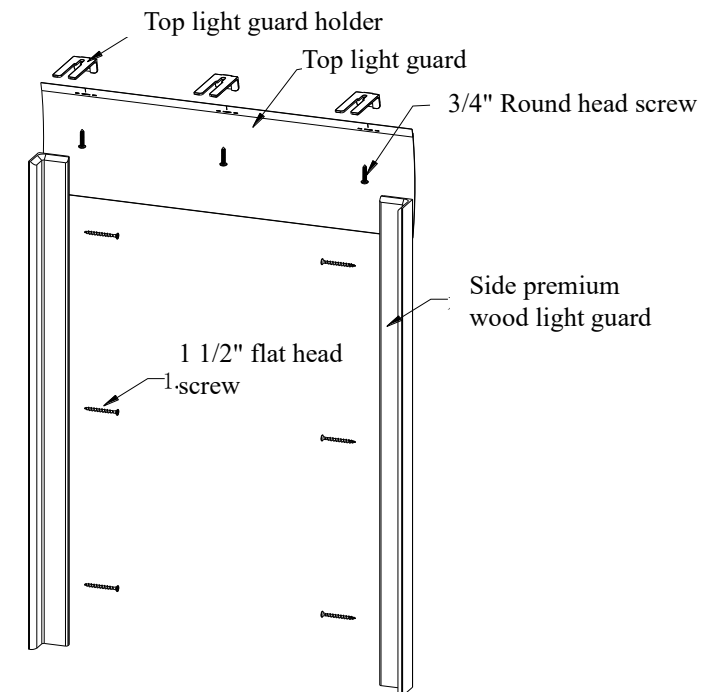

Install top light guard holder

Each top light guard holder needs one 3/4" round head screw for installation.

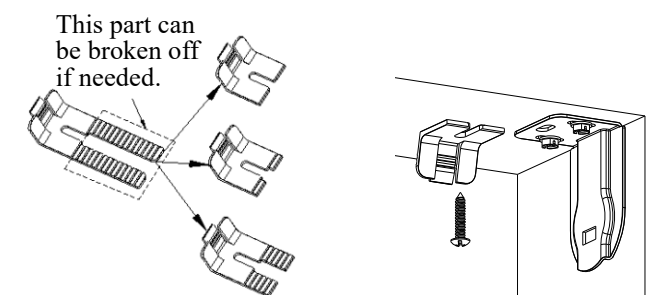

N300710-AH

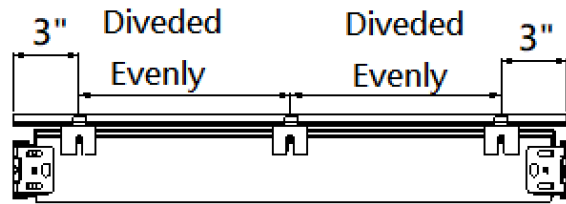

Install top light guard

Insert light guard to the back of top light guard holder and make sure the top of light guard meet the top of window firmly.

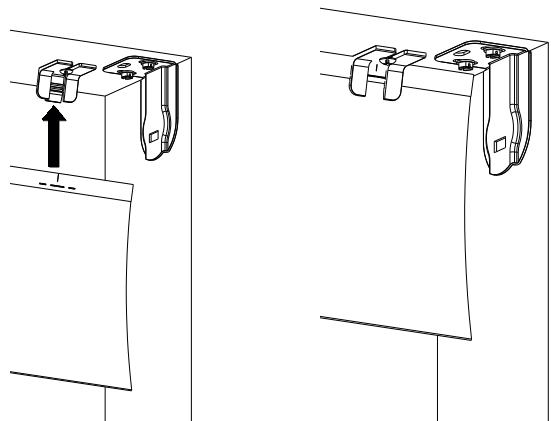

For roller shade with raceway system

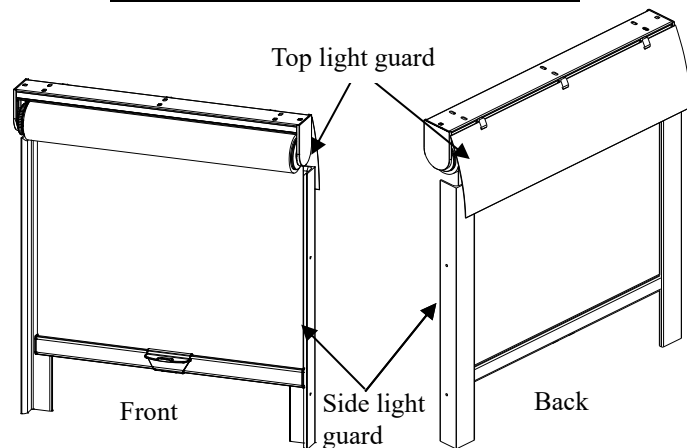

Install Top Light Guard

Insert the raceway light guard holder horizontally into the groove at the backside of raceway and turn 90 degrees to lock in the raceway groove. Then insert the top light guard into the groove of the raceway light guard holder.

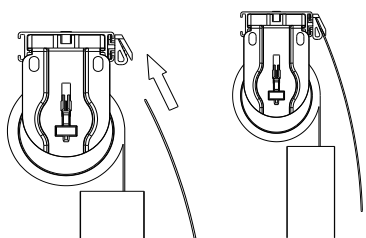
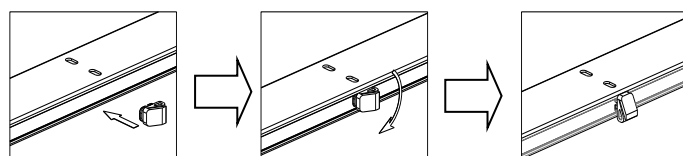

Installation of Side Light Guard

- Fully lower the shade down and make the wide side of light guard be next to the back of shade fabric.
For basic light guard, tear off the double- side tape on the narrow side and stick the light guard to the window frame. For better fixing the basic light guard to the window, please use 3/4" flat head screw to secure the light guard through the pre-drilled hole.
- For premium wood light guard, use 1 1/2" flat head screw to install.
- For better light blocking, the top of light guard should be placed next to the shade fabric and the bottom of light block is recommend to be installed sloping to the front.

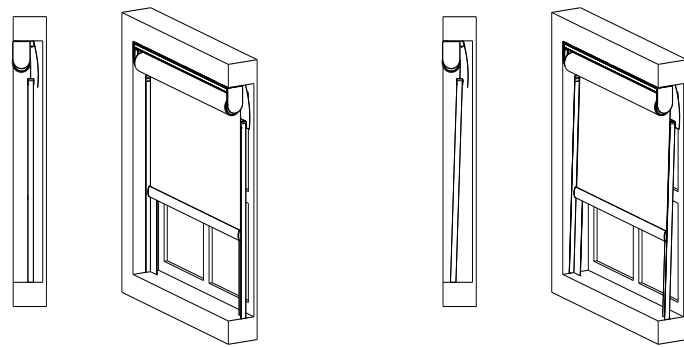

Installation of Transparent Adhesive Tape

Transparent adhesive tape is included for basic light guard length greater than 96" and spliced into 2 parts.

Installation: Align the double dotted line with the edge of the light guard, and fold the transparent adhesive tape on both sides, as shown in the figure below.

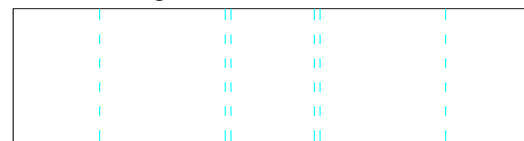

Transparent adhesive tape

